

VALEXTRA

SHEMESH AUTOMATION
PRUDENT PACKAGING SOLUTIONS



Advanced, high-speed, snap-on capper with smart orientation for round, oval and other shaped lids.

- **Speed:** Models offered in 60-200 products/minute range
- **Lids and containers complete orientation as needed**
- **Built-in quality control & defects reject system**
- **Industry 4.0 ready**



Let us build your vision



22B5

“Perfected over decades of continuous improvement with over 50 models sold globally, **VALEXTRA** has the classic Shemesh DNA: Consistency in production, accuracy, pragmatism, attention to details and robustness. It is a genuinely made-to-last capper of the highest standards in the industry.” **Shai Shemesh**, President

VALEXTRA

Ideal for infant formula packaging, canister wipes or any other snap-on application, **VALEXTRA** was specifically designed to apply round, oval and other shaped snap-on lids automatically,

accurately and consistently to containers. It offers customers multiple orientation functionality (container orientation, lid orientation and lid-to-container orientation).



Quick fact sheet

- **Fully automatic**
- Speed: models offered in **60-200** products/minute range (with orientation)
- **Sanitary** welding, design and build standard
- **Lids and containers orientation** as needed using servo, vision and proprietary mechanical designs
- Built-in **quality control** & defects reject system
- **Explosion proof** and **corrosion proof** models available
- Supporting both **oval, round** and **other shaped** lids and containers
- **Easy** and **fast** to **clean, format changeover** and **maintain**
- Compatible and seamlessly integrates with the rest of the Shemesh product portfolio
- **Industry 4.0** ready

STANDARD SPECS

- **Festo** (Germany) pneumatics and servo systems
- Complete **SST304/316L** design
- **FDA approved piping** as applicable
- **SIEMENS** (Germany) PLCs & HMIs and motors (Allen Bradley – optional)
- **BANNER** sensors
- **E-stop buttons** and **safety interlocks** wired through CAT IV safety controller
- **CE, ANSI, OSHA, NFPA** and **NEC** compliant



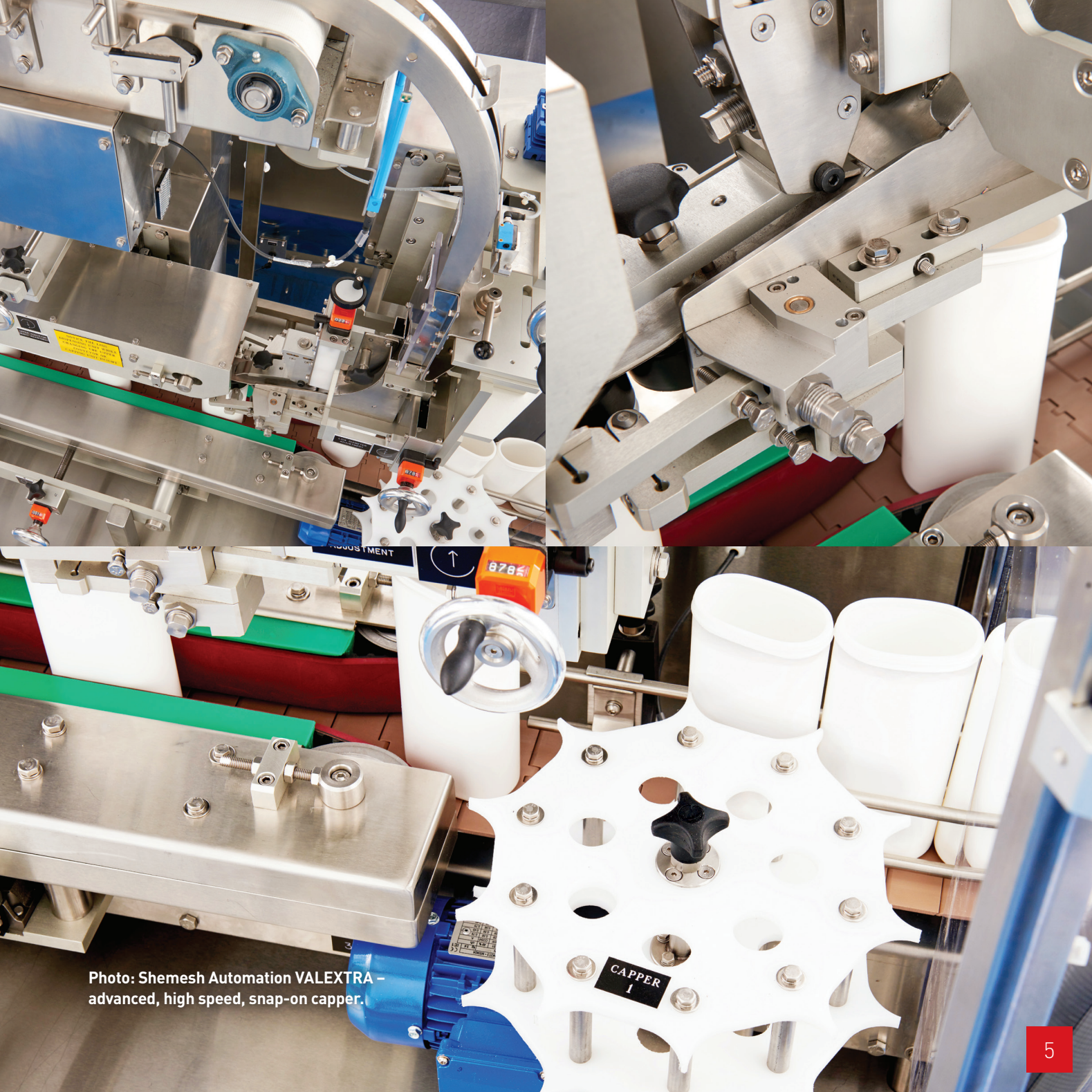

Photo: Shemesh Automation VALEXTRA - advanced, high speed, snap-on capper.



“Shemesh demonstrated time after time that they are ‘there’ when it really matters. From the project planning stage, where the line design and building of the kit were very well managed with clear communications at every stage, to delivering the project and equipment on time, and finally the installation stage, where Shemesh had a super professional team in place for installation & training. In addition to this, we are delighted with the productivity and the day to day operation where we all can enjoy production that is accurate and consistent. Today, I perceive Shemesh not only as an equipment supplier but a true partner to our success, and I also consider many within Shemesh friends. I am glad to say that we will surely buy from Shemesh again and I would not hesitate in putting my own name and reputation on the line in recommending the Shemesh brand to anyone who is looking for a reliable partner for their production needs.”

— **Rick Lennard**, Lead Engineer, Beams Packaging Services

Leaving the top hopper post with up/down orientation, lids are subsequently right/left oriented by a smart Festo servo & vision system.

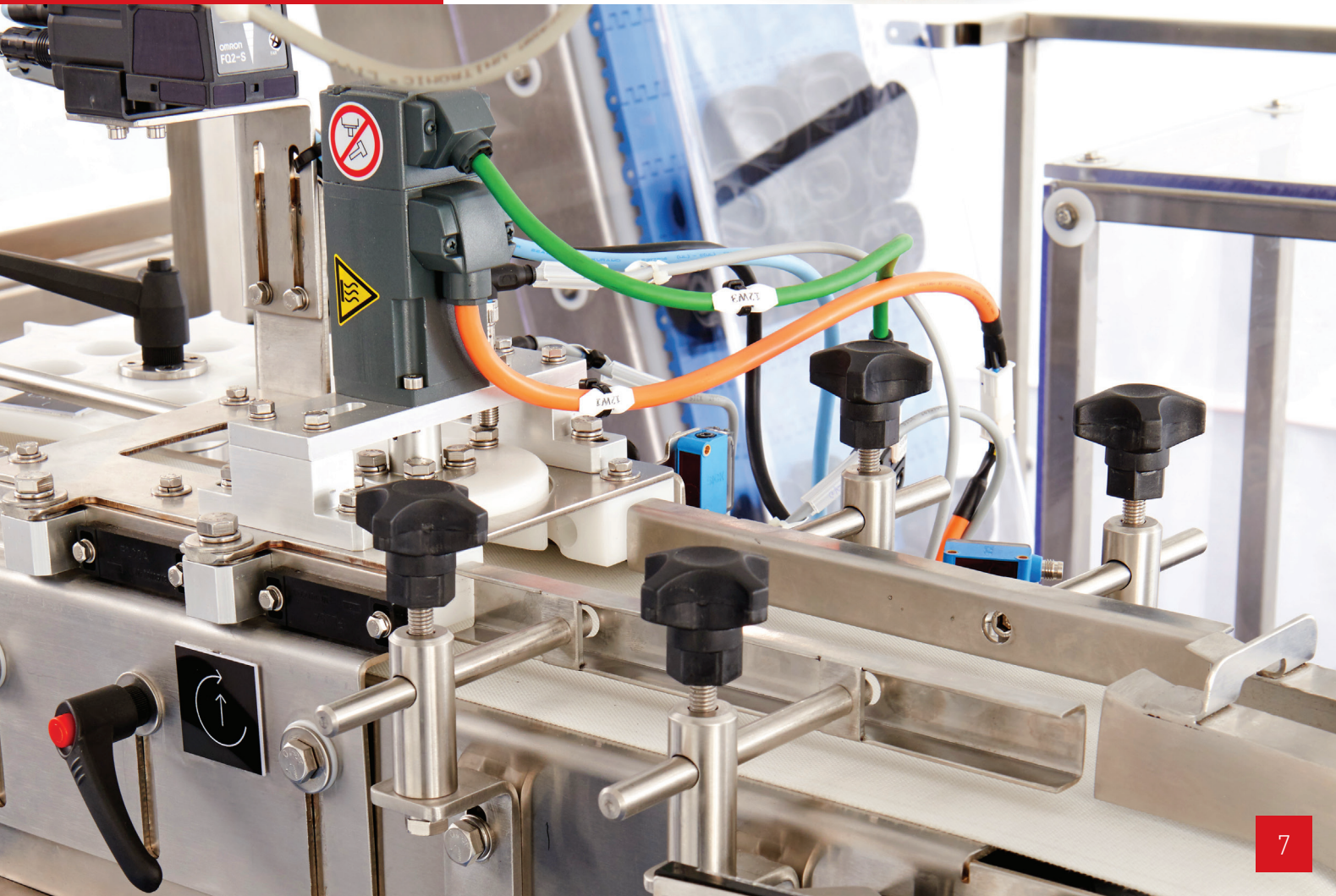

VALEXTRA: Key modules

VALEXTRA: key modules

- 1 Lids bottom hopper
- 2 Lids top hopper for 1st orientation (up-down)
- 3 Lids 2nd orientation (front-back)
- 4 Lids fastener
- 5 Lids dispenser

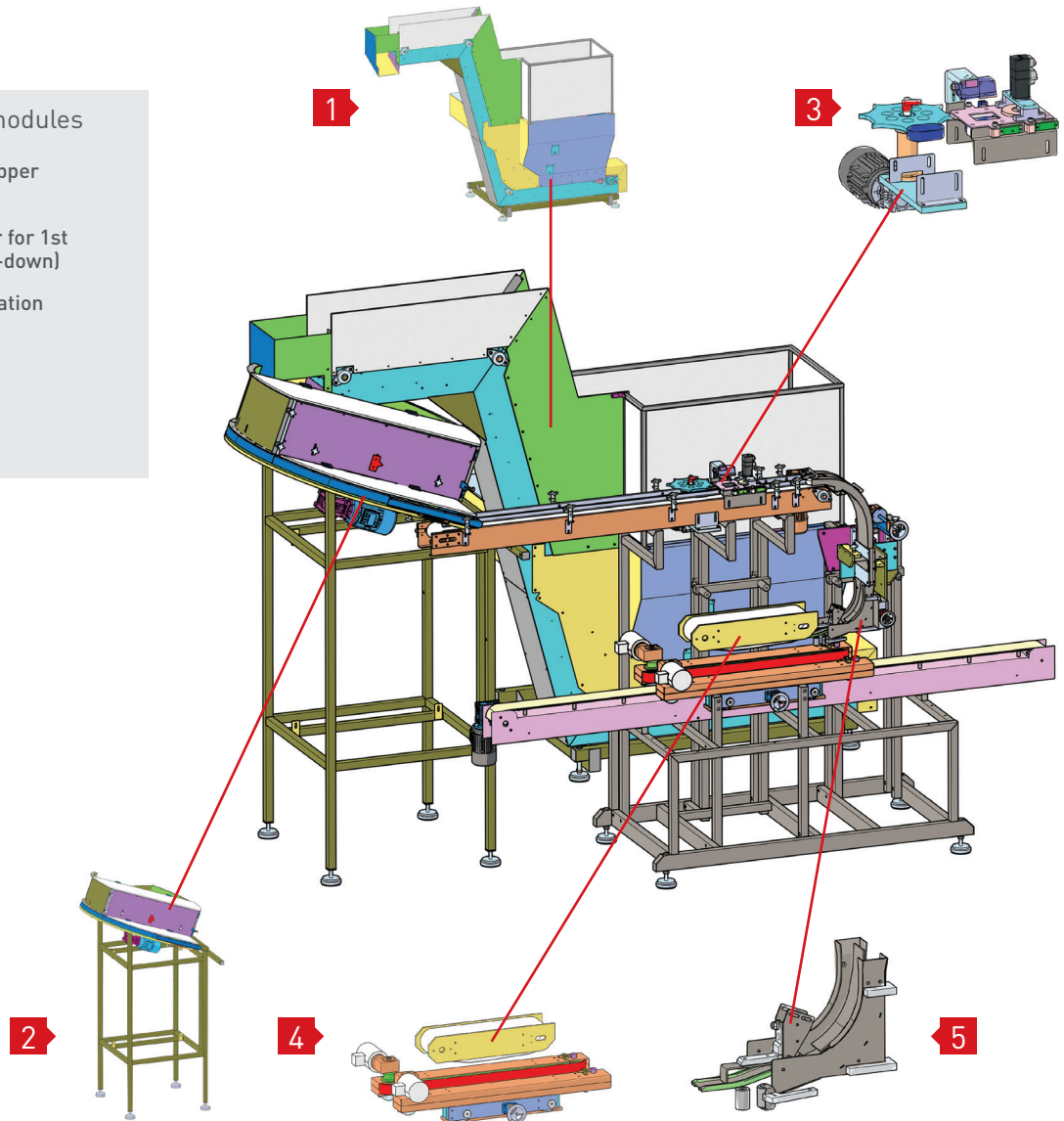

Basic indicative **VALEXTRA** layout

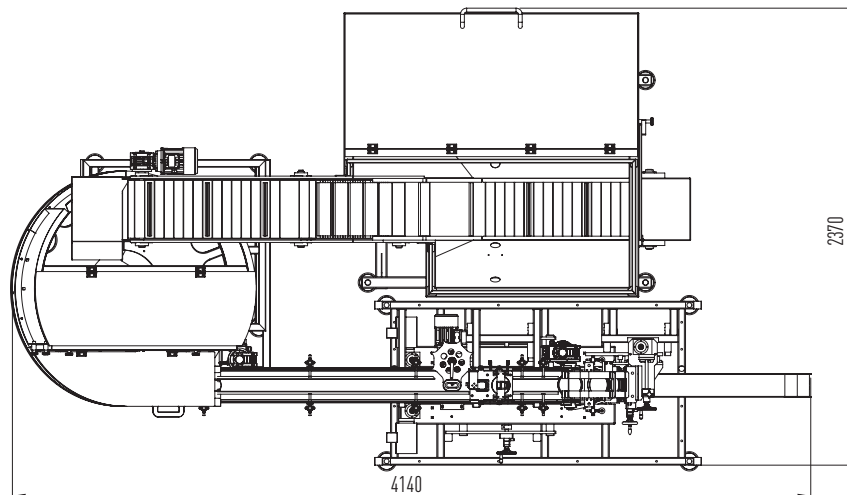
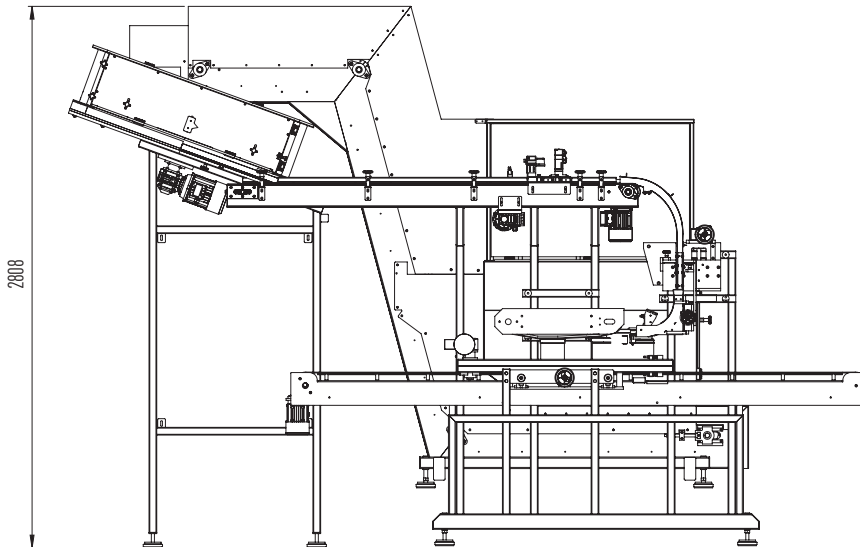



VALEXTRA's smart top lids hopper is one of two smart hoppers the machine features. The top hopper's proprietary design fastens partially open lids and up/down orientates them as needed.



VALEXTRA's built-in QC and reject system verifies that every product leaving the machine is properly lidded.

VALEXTRA is SST304-made and features high spec components including Siemens motors, HMIs and PLCs as well as Festo servo systems and is Industry 4.0 ready.

“Shemesh Automation is one of my favourite suppliers. Not only their equipment is reliable and innovative, but the people behind this name have also managed over the years to prove to us loyalty and service rarely seen in the industry.”

Gabi Cherniak,
Senior Project Manager, Teva
Pharmaceuticals Industries

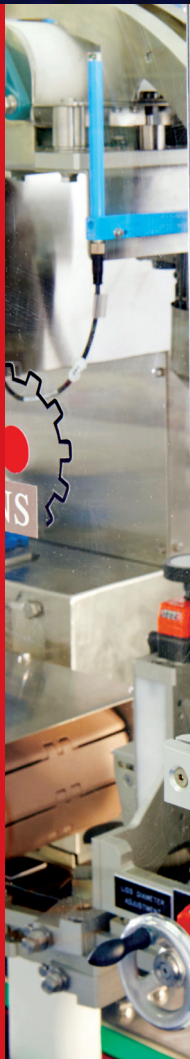

Global presence



Wisconsin, USA

North America HQ

State-of-the-art machine showroom, sales and after-sales support, spare parts inventory and North American logistics centre.

Hampshire, UK

Global Headquarters

CEO's office, Marketing, Strategy, Business Development and Finance.



Semur-en-Auxois, France

European HQ

French team, Tech centre featuring state-of-the-art machinery showroom, sales and after-sales support and European logistics centre.

Tel Aviv, Israel

R&D and Manufacturing

Operations, R&D, Engineering and Manufacturing.



WORLDWIDE

15

International branches

- United Kingdom
- North America
- France
- Latin America
- Israel
- Spain
- United Arab Emirates
- South Africa
- India
- China & Hong Kong
- Japan & Indonesia
- Australia & New Zealand

Over

1800

machines...

CAPACITY

x2

Manufacturing sites

...supported in over

30

countries

6 Trade shows per year



Global representation

Shemesh Automation collaborates with teams on complex Fortune 500 projects and has gained not only a proven and trusted network to put at your disposal, but also invaluable knowledge to help drive your projects.

We share our expertise to guarantee the maximum productivity of your machinery. Our global network of sales representatives and After Sales service specialists offer you flexible and efficient support. Our highly-qualified technicians ensure a fast solution whenever and wherever you need it.

REGIONAL HEADQUARTERS

United Kingdom

Shemesh Automation UK Ltd
Contact: Mr. Carl Gunaratnam

North America

Shemesh USA Inc
Contact: Mr. Jim Livermore

France

Shemesh Automation France
Contact: Ms. Nelly Desbiens

Israel

Shemesh Automation Israel Ltd
Contact: Mr. Luis Coronel

OTHER OFFICES

Spain

Shemesh Spain
Contact: Ms. Leticia Mulet

United Arab Emirates

Shemesh Automation UAE
Contact: Mr. Johann Van Niekerk

South Africa

Shemesh Automation SA
Contact: Mr. Simon Daniels

India

Shemesh Automation India
Contact: Mr. Shilpan Patel

China & Hong Kong

Shemesh Automation Asia
Contact: Mr. Charles Yip

Japan & Indonesia

Shemesh Automation Japan & Indonesia
Contact: Mr. Kentaro Taguchi

Australia & New Zealand

Shemesh Automation Australia
& New Zealand
Contact: Mr. Cameron McKenzie

LATIN AMERICA

Contact: Mr. Nir Baram

GLOBAL SALES

Contact: Mr. Luis Coronel



ATEX



ANTI-CORROSION



For all sales enquiries please contact us via sales@shemeshautomation.com

Explosion proofed & Corrosion proofed

Corrosive or alcohol-based solutions dictate that your equipment is duly fitted to professionally handle these delicate environments. Years of experience in the field made it possible for us to tailor for you the exact protection so your production is safe and stable while your people and equipment are well protected keeping your facility at the top of the range.

All of our machines are constructed using SST 304/316L, and are available with anti corrosive proprietary coating. As well as the machine base, all vital parts such as nozzles and pumps are also specially treated.



Built in ATEX rated commended ventilation systems for flammable fumes evacuation

Clean Machine Finishing

EX approved components such as Siemens motors, Banner sensors and Siemens PLCs and HMIs

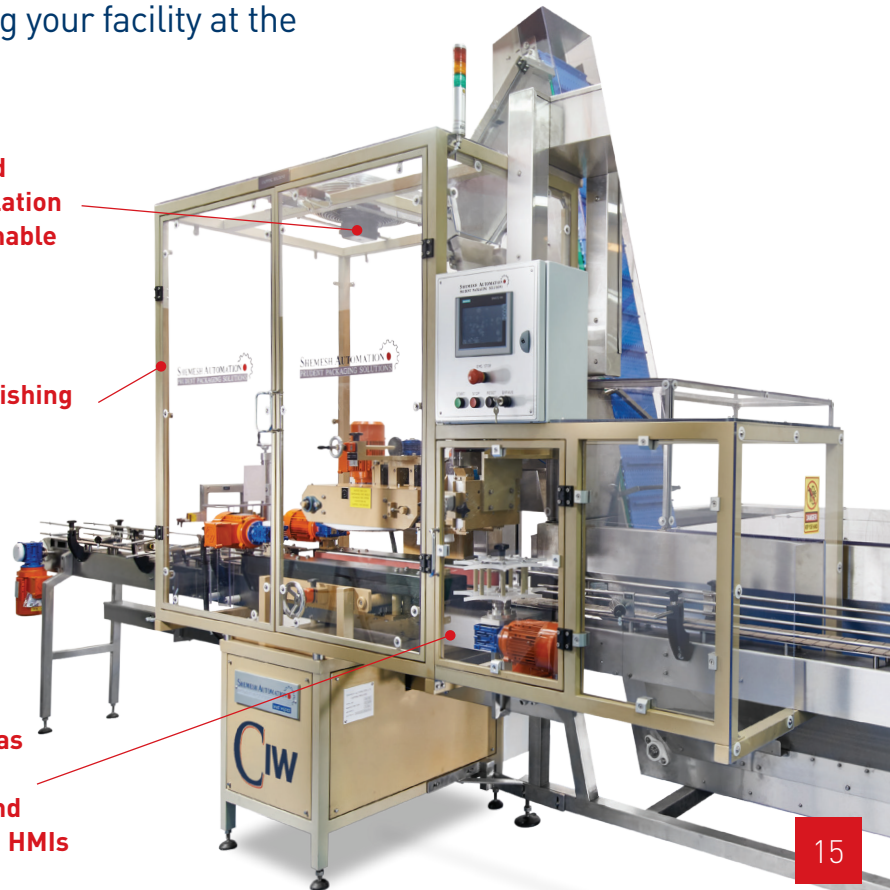

Offices:

United Kingdom

Shemesh Automation UK Ltd
85 Great Portland Street
First Floor
London W1W 7LT
United Kingdom
Tel. +44 758 428 1707



USA

Shemesh USA Inc
1040 Centennial Street
Green Bay
Wisconsin 54304
United States
Tel: +1 920 325 0050



Israel

Shemesh Automation Israel Ltd
4 Ha-Sar Khayim Moshe
Shapira St.
Rishon Lezion 7570406
Israel
Tel. +972 3550 9946



France

Shemesh Automation France
Bopak SARL Building
10 Rue de la Croix Belin
Semur-en-Auxois 21140
France
Tel. +33 (0) 615 210 409



www.shemeshautomation.com



Let us build your vision